

Industrial DC/DC CONVERTER CGDI Wide Input TETHYS : 30W POWER

Industrial
Grade ■



3:1 & 4:1 Wide Input Configurable Multiple Outputs Metallic case - 1 500 VDC Isolation



- Highly configurable DC/DC converter
- Up to 6 outputs and 3 independent line regulations
- Low profile : 0,33 " (8.5mm)
- Nominal Power of 30 W without derating
- Wide temperature range : -40°C/+95°C case
- Galvanic isolation 1.500 VDC
- Integrated LC EMI filter
- Permanent short circuit protection
- External trim and sense adjustment : +/-5%
- Inhibit function
- RoHS process

1-General

The TETHYS 30W wide input series is a full family of highly configurable DC/DC low profile module designed for use in distributed power architecture where variable input voltage and transient are prevalent and are particularly suitable for mobile application in transportation, or high-end industrial areas. This module uses a high frequency fixed switching technic at 480KHz providing excellent reliability, low noise characteristics and low profile package. Standard models are available with wide input voltage range of 4.7-16, 9-36, 16-40 or 36-140 volts. The serie includes thousands of output configuration from single, bi up to six output voltages in choice of 3,3, 5, 12, 15, 24 volts with trim and sense functions for output voltage adjustment.

No external heatsink is required for the CGDI series to supply 30W output power over the full temperature range.

All the modules are designed with LC network filters to minimize reflected input current ripple and output voltage ripple.

The modules include a soft-start, an input undervoltage lock-out, a permanent short circuit protection an output overvoltage protection and a thermal protection to ensure efficient module protections.

The soft-start allows current limitation and eliminates inrush current during start-up. The short circuit protection completely protects the module against short-circuits of any duration by a shut-down and restores to normal when the overload is removed. The thermal protection is adjusted to 110°C and protects the module against overheat.

The inhibit function is commanded with a low logic level and disables the module for applications requiring on/off operations.

The design has been carried out with surface mount components and is manufactured in a fully automated process to guarantee high quality. Each module is tested with a GAIA Converter automated test equipment.

2-Product Selection

Multiple output model : CGDI -

input - output - output - output

Input Voltage Range

Permanent	Transient
D : 4,7-16 VDC	n / a
H : 9-36 VDC	40 VDC / 100ms
J : 16-40 VDC*	45 VDC / 100ms
Q : 36-140 VDC**	175 VDC / 100ms

* for 45 VDC consult factory

** for 154 VDC consult factory

Output

3	: 3.3 VDC
5	: 5 VDC
5B	: +/-5VDC
12	: 12 VDC
12B	: +/-12VDC
15	: 15 VDC
15B	: +/-15VDC
24	: 24 VDC
24B	: +/- 24VDC

2- Product Selection (continued)

Single line model	: CGDI-	<input type="checkbox"/>	-	<input type="checkbox"/>	-	0	-	0	>	30 W first line output : primary output
Dual line model	: CGDI-	<input type="checkbox"/>	-	<input type="checkbox"/>	-	0	-	<input type="checkbox"/>	>	20 W first line output : primary output > 10 W second line output : secondary output
Triple line model	: CGDI-	<input type="checkbox"/>	-	<input type="checkbox"/>	-	<input type="checkbox"/>	-	<input type="checkbox"/>	>	10 W on each line output : primary and secondary outputs

First line output functions :	Trim function at +/- 5% Sense function at +/- 5% Tight regulation below 1% Indefinite short circuit protection
Secondary line output functions :	Independant regulation from primary output Indefinite short circuit protection

Input Voltage Range	
Designation	Permanent
D	4,7-16 VDC
H	9-36 VDC
J	16-40 VDC*
Q	36-140 VDC**

* for 45 VDC consult factory
** for 154 VDC consult factory

Output Voltage	
Designation	Output Voltage
3	3.3 VDC
5	5 VDC
5B	+/-5VDC
12	12 VDC
12B	+/-12VDC
15	15 VDC
15B	+/-15VDC
24	24 VDC
24B	+/-24VDC

5

Converter Selection Chart

CGDI - Q - 5 - 0 - 12B

<p>Input voltage range : D : 4,7-16 VDC H : 9-36 VDC J : 16-40 VDC* Q : 36-140 VDC**</p> <p>Output voltage : 5 : 5 Vdc, 20W First line 12B : +/-12 Vdc, 10W second line See table page 1 for complete possibilities</p>	
---	--

3- Electrical Specifications

Data are valid at +25°C, unless otherwise specified.

Parameter	Conditions	Limit or typical	Units	CGDI-D	CGDI-H
Input					
Nominal input voltage	Full temperature range	Nominal	VDC	9	20
Permanent input voltage range (Ui)	Full temperature range	Min. - Max.	VDC	4,7-16	9-36
Extended permanent input voltage range	Full temperature range (consult factory)	Min. - Max.	VDC	/	/
Transient input voltage	Full load	Maximum	VDC/S	/	40/0,1
Undervoltage lock-out (UVLO)	Threshold	Minimum	VDC	4	7
		Maximum	VDC	4,5	8,5
Start up time	Ui nominal	Maximum	ms	40	40
	Nominal output Full load : resistive				
Reflected ripple current	Ui nominal, full load at switching freq. BW = 20MHz	Maximum	mApp	50	50
Input current in short circuit mode (Average)	Ui nominal Short-circuit	Maximum	mA	100	60
No load input current	Ui nominal No load	Maximum	mA	100	60
Primary Output					
Output voltage *	Ui min. to max. 75% load	Nominal	VDC	3,3V , 5V , 12V , 15V or 24V <i>Consult factory for other outputs</i>	
Set Point accuracy + Line regulation + Load regulation	Ambient temperature : +25°C Ui min. to max. 25% to full load	Maximum	%	+/- 1	+/- 1
Output power **	Full temperature range Ui min. to max.	Maximum	W	10, 20 or 30 (limited to respectively 2A, 4A or 6A max)	
Ripple output voltage *** 3,3V and 5V output 12V output 15V and 24V output	Ui nominal	Maximum	mVpp	40	40
	Full load	Maximum	mVpp	50	50
	BW = 20MHz	Maximum	mVpp	60	60
Trim function	Ui nominal	Maximum	%	+ 5	+ 5
		Minimum	%	- 5	- 5
Sense function	Ui nominal	Maximum	%	+ 5	+ 5
		Minimum	%	- 5	- 5
Secondary Output					
Output voltage *	Ui min. to max. 75% load	Nominal	VDC	3,3V , 5V , 12V , 15V or 24V +/- 5V , +/- 12V , +/- 15V or +/- 24V <i>Consult factory for other outputs</i>	
Set point accuracy	Ambient temperature : +25°C Ui nominal, 75% load	Maximum	%	+/- 2	+/- 2
Output power	Full temperature range Ui min. to max.	Maximum	W	10 or 20 (limited to respectively 2A or 4A max)	10 or 20 (limited to respectively 2A or 4A max)
Ripple output voltage ** 3,3V, 5V and +/-5V output 12V and +/-12V output 15V and +/-15V output 24V and +/-24V output	Ui nominal	Maximum	mVpp	50	50
	Full load	Maximum	mVpp	100	100
	BW = 20MHz	Maximum	mVpp	150	150
		Maximum	mVpp	150	150
Line regulation	Ui min. to max. Full load	Maximum	%	+/- 1	+/- 1
Load regulation ***	Ui nominal 25% to full load	Maximum	%	+/- 2,5	+/- 2,5

Note * : For proper operation the CGDI module requires to install a 22µF chemical or tantalum capacitance across output terminals.

Note ** : For 9-36V inpt range, the power is derated at 80% at 9V and increases linearly to full power at 12V.

Note*** : The ripple output voltage is the periodic AC component imposed on the output voltage, an aperiodic and random component (noise) has also to be considered. This noise can be reduced by adding an external capacitor (typically 10nF/rated voltage depending on isolation requirement) connected between the pin Gin and the pin Gout of the converter. This capacitor should be layed-out as close as possible from the converter.

Note **** : For load regulation characteristics from 0% to full load, please contact factory.

3- Electrical Specifications (continued)

Data are valid at +25°C, unless otherwise specified.

Parameter	Conditions	Limit or typical	Units	CGDI-J	CGDI-Q
Input					
Nominal input voltage	Full temperature range	Nominal	VDC	28	72
Permanent input voltage range (Ui)	Full temperature range	Min. - Max.	VDC	16-40	36-140
Extended permanent input voltage range	Full temperature range (consult factory)	Min. - Max.	VDC	16-45	36-154
Transient input voltage	Full load	Maximum	VDC/S	45/0,1	175/0,1
Undervoltage lock-out (UVLO)	Threshold	Min. - Max.	VDC	12-15	/
Start up input voltage	Threshold	Minimum	VDC	/	33
Start up time	Ui nominal Nominal output Full load : resistive	Maximum	ms	40	40
Reflected ripple current	Ui nominal, full load at switching freq. BW = 20MHz	Maximum	mApp	50	50
Input current in short circuit mode (Average)	Ui nominal Short-circuit	Maximum	mA	60	60
No load input current	Ui nominal No load	Maximum	mA	60	60
Primary Output					
Output voltage *	Ui min. to max. 75% load	Nominal	VDC	3,3V , 5V , 12V , 15V or 24V <i>Consult factory for other outputs</i>	
Set Point accuracy + Line regulation + Load regulation	Ambient temperature : +25°C Ui min. to max. 25% to full load	Maximum	%	+/- 1	+/- 1
Output power	Full temperature range Ui min. to max.	Maximum	W	10, 20 or 30	
Ripple output voltage ** 3,3V and 5V output 12V output 15V and 24V output	Ui nominal Full load BW = 20MHz	Maximum Maximum Maximum	mVpp mVpp mVpp	40 50 60	40 50 60
Trim function	Ui nominal	Maximum Minimum	% %	+ 5 - 5	+ 5 - 5
Sense function	Ui nominal	Maximum Minimum	% %	+ 5 - 5	+ 5 - 5
Secondary Output					
Output voltage *	Ui min. to max. 75% load	Nominal	VDC	3,3V , 5V , 12V , 15V or 24V +/- 5V , +/- 12V , +/- 15V or +/- 24V <i>Consult factory for other outputs</i>	
Set point accuracy	Ambient temperature : +25°C Ui nominal, 75% load	Maximum	%	+/- 2	+/- 2
Output power	Full temperature range Ui min. to max.	Maximum	W	10 or 20	10 or 20
Ripple output voltage ** 3,3V, 5V and +/-5V output 12V and +/-12V output 15V and +/-15V output 24V and +/-24V output	Ui nominal Full load BW = 20MHz	Maximum Maximum Maximum Maximum	mVpp mVpp mVpp mVpp	50 100 150 150	50 100 150 150
Line regulation	Ui min. to max. Full load	Maximum	%	+/- 1	+/- 1
Load regulation	Ui nominal 25% to full load	Maximum	%	+/- 2,5	+/- 2,5

Note * : For proper operation the CGDI module requires to install a 22µF chemical or tantalum capacitance across output terminals.

Note** : The ripple output voltage is the periodic AC component imposed on the output voltage, an aperiodic and random component (noise) has also to be considered. This noise can be reduced by adding an external capacitance (typically 10nF/rated voltage depending on isolation requirement) connected between the pin Gin and the pin Gout of the converter. This capacitance should be layed-out as close as possible from the converter.

4- Switching Frequency

Parameter	Conditions	Limit or typical	Specifications
Switching frequency	Full temperature range Ui min. to max. No load to full load	Nominal, fixed	4.7-16 VDC input : 480 KHz 9-36 VDC input : 480 KHz 16-40 VDC input : 480 KHz 36-140 VDC input : 430 KHz

5- Isolation

Parameter	Conditions	Limit or typical	Specifications
Electric strength test voltage (basic version)	Input to output	Minimum	1 500 VDC / 1 min
Electric strength test voltage between outputs (for outputs of the same line of regulation)	Output to output	Minimum	No isolation
Electric strength test voltage between outputs (for outputs of different line of regulation)	Output to output	Minimum	500 VDC / 1 min.
Isolation resistance	500 VDC	Minimum	100 MOhm

6- Protection Functions

Characteristics	Protection Device	Recovery	Limit or typical	Specifications
Output short circuit protection (SCP)	Hiccup circuitry with auto-recovery	Automatic recovery	Permanent	See section 12
Output overvoltage protection (OVP)	Zener clamp	/	Maximum Maximum Maximum Maximum	For 3.3v : 4v For 5v : 6v For 12v : 14v For 15v : 17v
over temperature protection (OTP)	Thermal device with hysteresis cycle	Automatic recovery	Nominal	115°C

7- Reliability Data

Characteristics	Conditions	Temperature	Specifications
Mean Time Between Failure (MTBF) According to MIL-HDBK-217F	Ground fixed (Gf)	Case at 40°C Case at 70°C	480.000 Hrs 190.000 Hrs
	Ground mobile (Gm)	Case at 40°C Case at 70°C	Consult factory
Mean Time Between Failure (MTBF) According to IEC-62380-TR	Railway, Payphone	Ambient at 25°C 100% time on	195 000 Hrs

8- Electromagnetic Interference

Electromagnetic interference requirements according to EN55022 class A and class B can be easily achieved as indicated in the following table :

Electromagnetic Interference according to EN55022			
Conducted noise emission	Configuration	With common mode capacitor $C_c = 10\text{nF}$ and input capacitor C_i	With common mode capacitor $C_c = 10\text{nF}$ and external filter
	Models		
Conducted noise emission	4,7-16V input models	Class A, $C_i = 10\mu\text{F} / 35\text{ V tantalum} + \text{inductance } 4,7\text{ mH}$	Class B
	9-36V input models	Class A, $C_i = 4,7\mu\text{F} / 50\text{ V tantalum}$	Class B
	16-40V input models	Class A, $C_i = 4,7\mu\text{F} / 50\text{ V tantalum}$	Class B
	36-140V input models	Class A, $C_i = 47\mu\text{F} / 200\text{ V tantalum}$	/
Radiated noise emission	Configuration	With common mode capacitor $C_c = 10\text{ nF}$	
	Models	Class B	
	All models		

8-1 Module Compliance with EN 55022 Class B

To meet EN55022 Class B requirements, Gaia Converter recommends the use of front filter (see EN55022 Class B EMI Filter design note) together with a common mode noise capacitance C_c (10nF/rated voltage depending on isolation requirement) connected between G_{in} and G_{out} .

This common mode noise capacitance C_c should be laid-out as close as possible from the DC/DC converter. The typical schematic hereafter describes the Tethys used in a 4 outputs configuration (exemple 5V/2A, 3.3V/ 2A and +/-15V) with front filter, common mode noise C_c and output capacitance to reduce output ripple voltage.

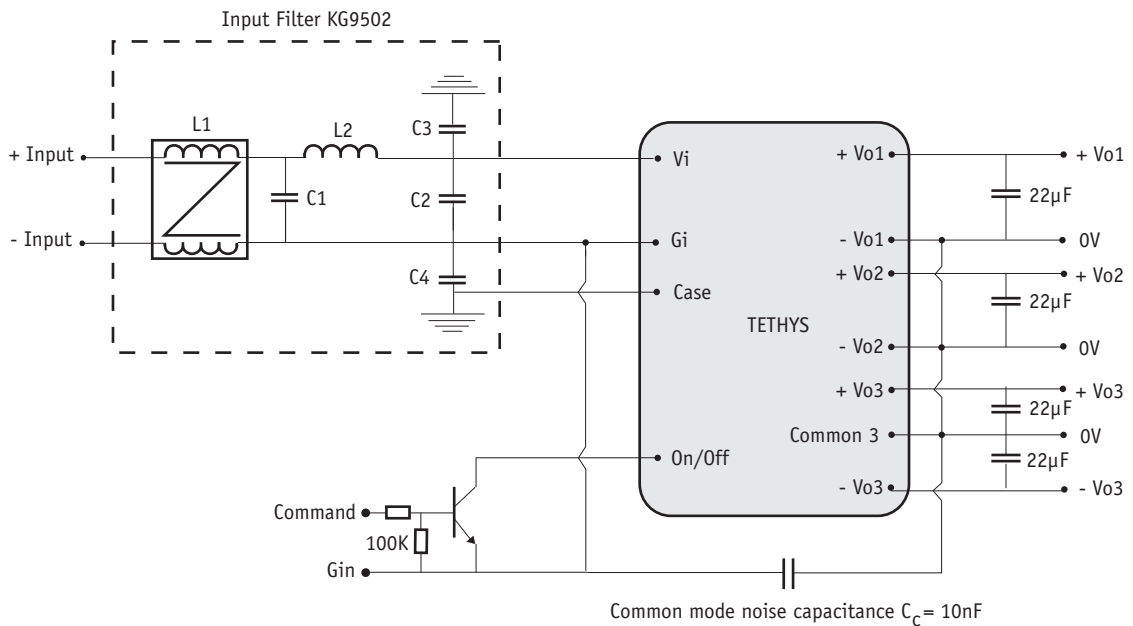

9- Surge Susceptibility EN61000-4-5 & EN50155

Surge susceptibility requirements according to EN50155, EN61000-4-5 and electromagnetic interference requirements of EN55022 class A can easily be achieved using either :

- a limiter module LGDS-50 series : ready-to-use single module solution,
- an input limiter filter : schematics of discret components, to sustain the following surge levels :

Characteristics	Standards	Levels
Spikes Line to line	EN 61000-4-5	Level 4 with 4.000 V waveform 50 μ s, impedance 2 Ohm
	EN 50155	Level 1.800 V waveform 50 μ s, impedance 100 and 5 Ohm Level 8.400 V waveform 0.1 μ s, impedance 100 Ohm
Spikes Line to earth	EN 61000-4-5	Level 4 with 4.000 V waveform 50 μ s, impedance 12 Ohm
	EN 50155	Level 1.800 V waveform 50 μ s, impedance 100 and 5 Ohm Level 8.400 V waveform 0.1 μ s, impedance 100 Ohm

9-1 Surge Protection with Off-the-Shelf Solution : LGDS-50 Limiter Module

To sustain surge requirements of EN61000-4-5, and EN50155 together with EN55022 class A, GAIA Converter proposes a ready-to-use single product. Depending on bus input range two references of limiter module are existing with references as follow :

Input types	DC/DC converter family	Limiter module reference
9-36 VDC Input	CGDI-10-H series	LGDS-50-J-K
16-40 VDC Input	CGDI-10-J series	LGDS-50-J-K
36-140 VDC Input	CGDI-10-Q series	LGDS-50-Q-K

These modules designated LGDS-50 series are designed up to 50W power and will protect CGDI series with 9-36, 16-40 or 36-140 VDC input against surges.

The implantation of LGDS-50 with modules can be undertook as follow :

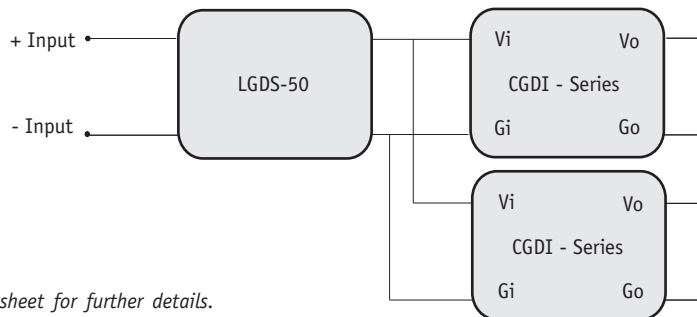

Please consult LGDS-50 datasheet for further details.

9-2 Surge Protection with Discrete Components

To sustain surge requirements of EN61000-4-5 and EN50155 together with EN55022 class A, GAIA Converter proposes the following front protection filter.

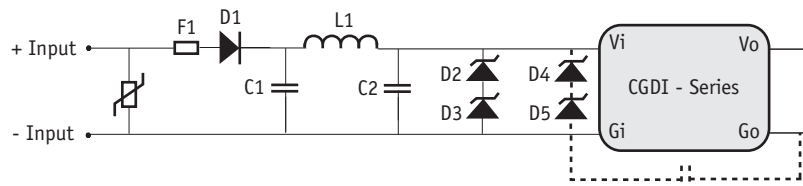

* Common mode noise capacitance $C_c = 10nF$

Please consult EN50155 Transient/EMI filter design note for further details.

* Note : Value of common mode noise capacitance rated voltage depends on isolation requirements.

10- Thermal Characteristics

Characteristics	Conditions	Limit or typical	Performances
Operating ambient temperature range at full load	Ambient temperature *	Minimum Maximum	- 40°C + 71°C
Operating case temperature range at full load	Case temperature	Minimum Maximum	- 40°C +95°C
Storage temperature range	Non functioning	Minimum Maximum	- 40°C + 105°C
Thermal resistance	Rth case to ambient in free air natural convection	Typical	4°C /W

Note *: The upper temperature range depends on configuration, the user must assure a max. case temperature of + 95°C.

The CGDI series operating **case** temperature must not exceed 95°C. The maximum **ambient** temperature admissible for the DC/DC converter corresponding to the maximum operating case temperature of 95°C depends on the ambient airflow, the mounting/orientation, the cooling features and the power dissipated.

To calculate a maximum admissible ambient temperature the following method can be used. Knowing the maximum case temperature Tcase = 95°C of the module, the power used Pout and the efficiency η :

- determine the power dissipated by the module P_{diss} that should be evacuated :

$$P_{diss} = P_{out}(1/\eta - 1)$$

- determine the maximum ambient temperature :

$$T_a = 95^\circ\text{C} - R_{th} \times P_{diss}$$

where **Rth** is the thermal resistance from the case to ambient.

The previous thermal calculation shows two areas of operation :

- a normal operation area in a free natural ambient convection (grey area in this following graph),
- an area with cooling features (air flow or heatsink) ensuring a maximum case temperature below the maximum operating case temperature of 95°C (white area in the following graph).

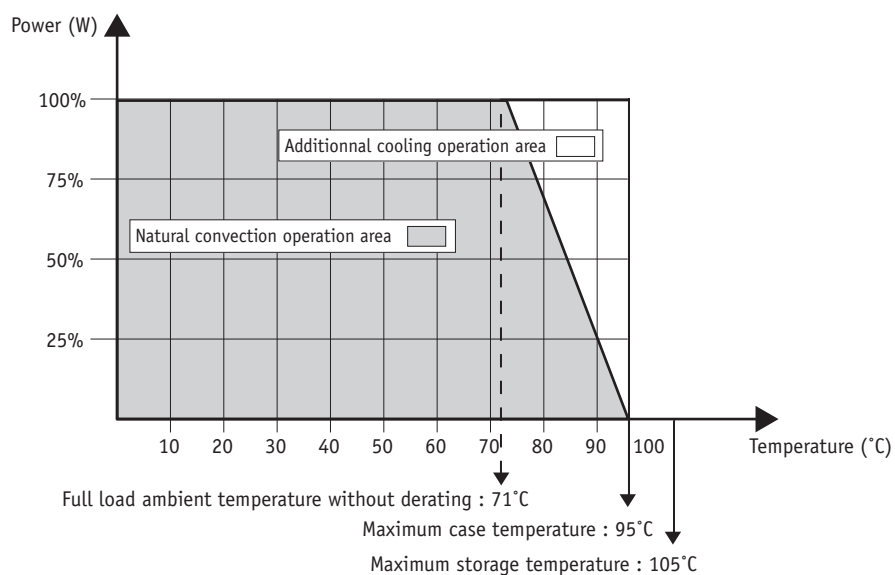

11- Environmental Qualifications

The modules have been subjected to the following environmental qualifications.

Characteristics	Conditions	Severity	Test procedure
Climatic Qualifications			
Life at high temperature	Duration Temperature Status of unit	1.000 Hrs 95°C case unit operating	IEC 68-2-2
Humidity steady	Damp heat Temperature Duration Status of unit	93 % relative humidity 40°C 56 days unit not operating	IEC 68-2-3 Test Ca
Temperature cycling	Number of cycles Temperature change Transfert time Steady state time Status of unit	200 -40°C / +71°C 40 min. 20 min. unit not operating	IEC 68-2-14 Test N
Temperature shock	Number of shocks Temperature change Transfert time Steady state time Status of unit	50 -40°C / +105°C 10 sec. 20 min. unit not operating	IEC 68-2-14 Test Na
Mechanical Qualifications			
Vibration (Sinusoidal)	Number of cycles Frequency : amplitude Frequency : acceleration Amplitude /acceleration Duration Status of unit	10 cycles in each axis 10 to 60 Hz / 0.7 mm 60 to 2000 Hz / 10 g 0.7 mm/10 g 2h 30 min. per axis unit not operating	IEC 68-2-6 Test Fc
Shock (Half sinus)	Number of shocks Peak acceleration Duration Shock form Status of unit	3 shocks in each axis 100 g 6 ms 1/2 sinusoidal unit not operating	IEC 68-2-27 Test Ea
Bump (Half sinus)	Number of bumps Peak acceleration Duration Status of unit	2000 bumps in each axis 25 g 6 ms unit not operating	IEC 68-2-29 Test Eb
Electrical Immunity Qualifications			
Electrical discharge susceptibility	Number of discharges Air discharge level Contact discharge level Air discharge level Contact discharge level	10 positive & 10 negative discharges 4 kV : sanction A 2 Kk : sanction A 8 Kk : sanction B 4 kV : sanction B	EN55082-2 with : EN61000-4-2 IEC 801-2
Electrical field susceptibility	Antenna position Electromagnetic field Wave form signal Frequency range	at 1 m 10 V/m AM 80%, 1 kHz 26 MHz to 1 GHz	EN55082-2 with : EN61000-4-3 IEC801-3
Electrical fast transient susceptibility	Burst form Wave form signal Impedance Level 1 Level 3	5/50 ns 5 kHz with 15 ms burst duration period 300 ms 50 Ohm 0,5 kV : sanction A 2 kV : sanction B	EN55082-2 with : EN61000-4-4 IEC801-4
Surge Susceptibility	Surge form Impedance Level 4	1,2/50 µs 2 Ohm 4 kV : with transient protection or LGDS-50 limiter module (see section surge)	EN61000-4-5 EN50155

12- Description of Protections

12-1 Input Undervoltage Lock-out (UVLO)

The input undervoltage lock-out protection device turns-on and turns-off the output voltage when the input bus voltage reaches the undervoltage lock-out threshold. There is no hysteresis cycle at turn-on and turn-off.

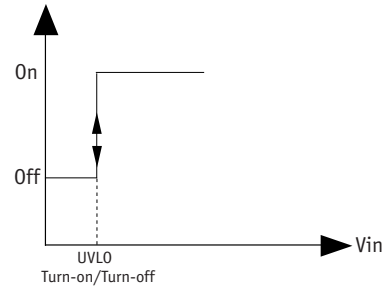

12-2 Output Short Circuit Protection (SCP)

The short circuit protection device protects the module against short circuit of any duration and restores the module to normal operation when the short circuit is removed. It operates in «hiccup» mode by testing periodically if an overload is applied (typically every 200ms recovery time). The overload detection threshold is typically 200% of maximum current with a detection time lower than 5ms.

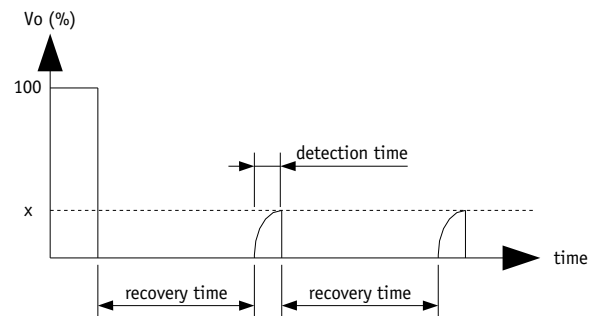

12-3 Output Overvoltage Protection (OVP)

The output overvoltage protection device protects external components against high voltage or possible overvoltages which can be supplied by the module (i.e in case of internal failure). It consists of a zener diode clamping the output voltage; under worst case conditions this zener diode will short-circuit.

The output voltage protection is not designed to withstand externally applied output overvoltages to protect the module itself.

12-4 Over Temperature Protection (OTP)

A thermal protection device adjusted at 115°C (+/-5%) internal temperature with 10°C hysteresis cycle will inhibit the module as long as the overheat is present and restores to normal operation automatically when overheat is removed. The efficiency of the OTP function is warranty with the module mounted on a heatsink.

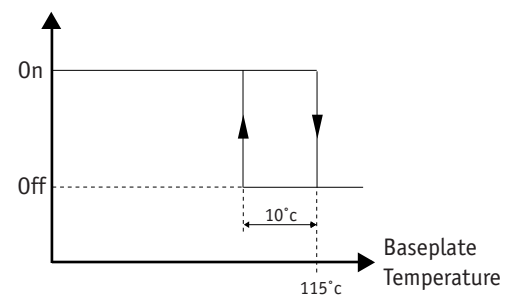

13- Description of Functions

13-1 On/Off Function

The control pin 16 (On/Off) can be used for applications requiring On/Off operation. By using an open collector command with a transistor Q referenced to the common terminal (Gi) :

- A logic pulled low (<math><0.2V@1mA</math>, referenced to Gi) on pin 16 disables the converter
- No connection or high impedance on pin 16 enables the converter.

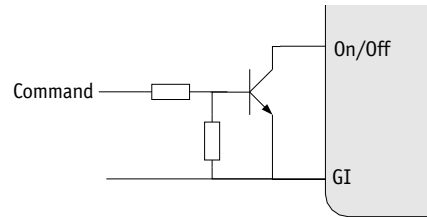

By releasing the On/Off function, the converter will restart within the start-up time specifications given in table page 3. For further details please consult "Logic On/Off" application note.

13-2 Trim Function

The primary output voltage Vo1 may be trimmed at +/-5% via a single external trimpot or fixed resistor. The trimpot should be connected as shown in figure hereafter. Value of the trim resistance is given in the following table :

Vo1	R1 Value	Vo1	R1 Value
2,5 V	0 Ohm	12 V	12 KOhm
3,3 V	0 Ohm	15 V	22 KOhm
5 V	0 Ohm	24 V	36 KOhm

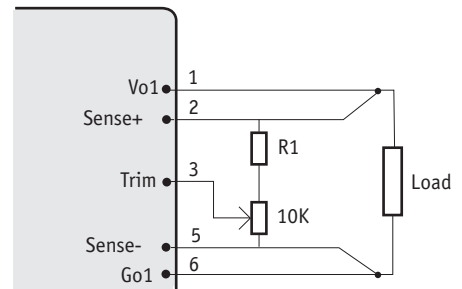

13-3 Sense Function

If the load is separated from the output by any line length, some of these performance characteristics will be degraded at the load terminals by an amount proportional to the impedance of the load leads. With the sense function, the voltage at the power supply output shifts by up to the maximum allowed voltage per load line to compensate the voltage drop in the load leads, there by maintaining a constant voltage at the load terminals.

Both Trim and Sense function can be combined but the compensation voltage must not exceed 0.5V max or +/-5% of the output voltage.

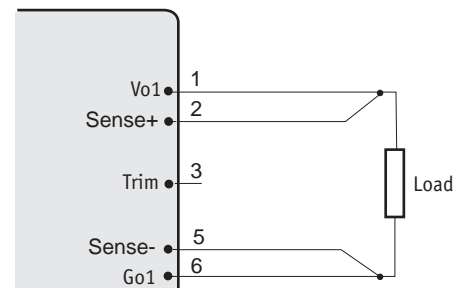

14- Application Notes

14-1 Parallel operations

Tethys series can be used in parallel to increase output power. Up to 3 Tethys can be used to add power up to a maximum of 90W. Contact factory for further details.

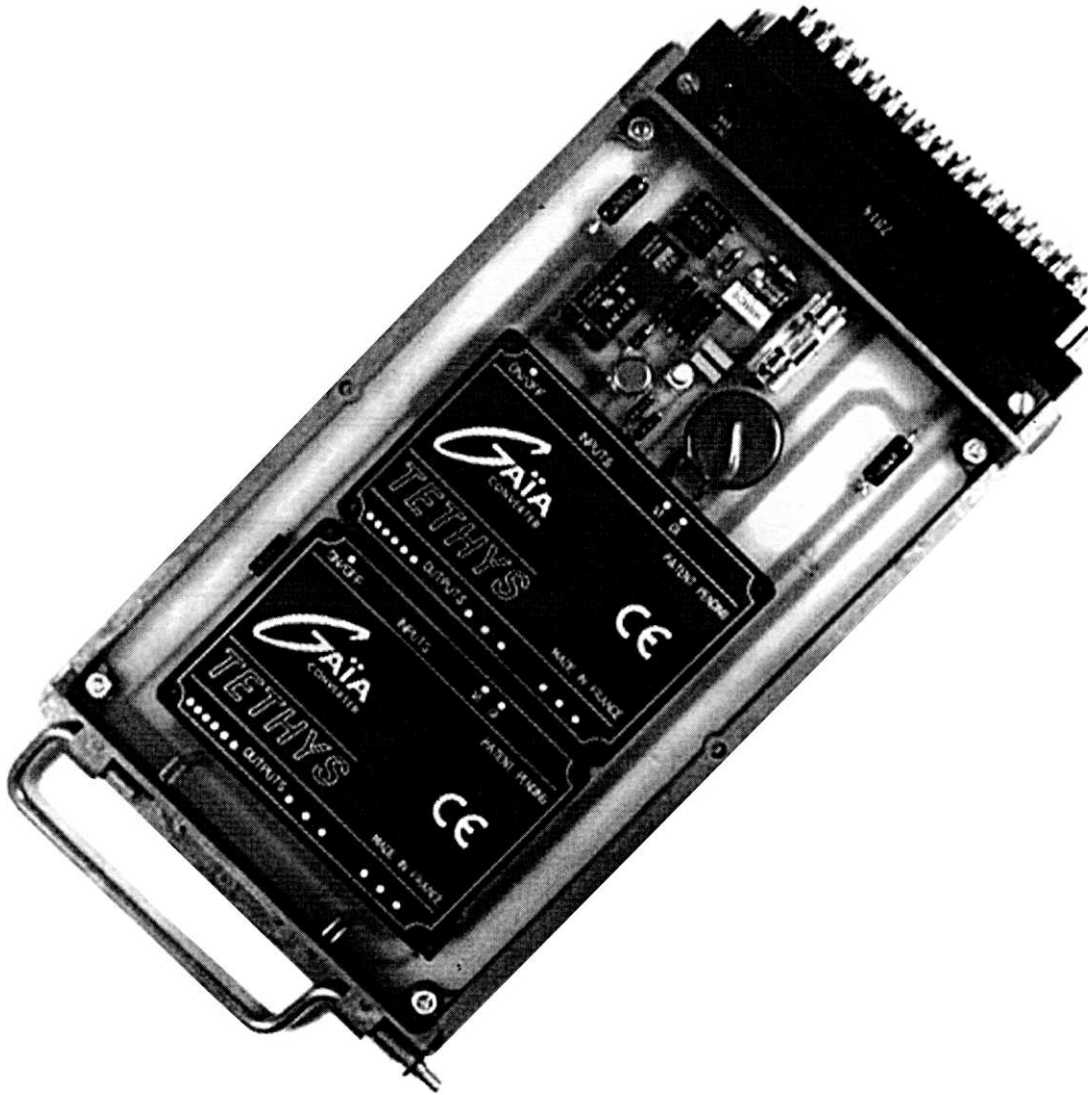

15- Dimensions

Dimension are given in mm (inches). Tolerance : +/- 0,2 mm (+/- 0.01 ") unless otherwise indicated.
Weight : 85 grams (2.9 Ozs) max.

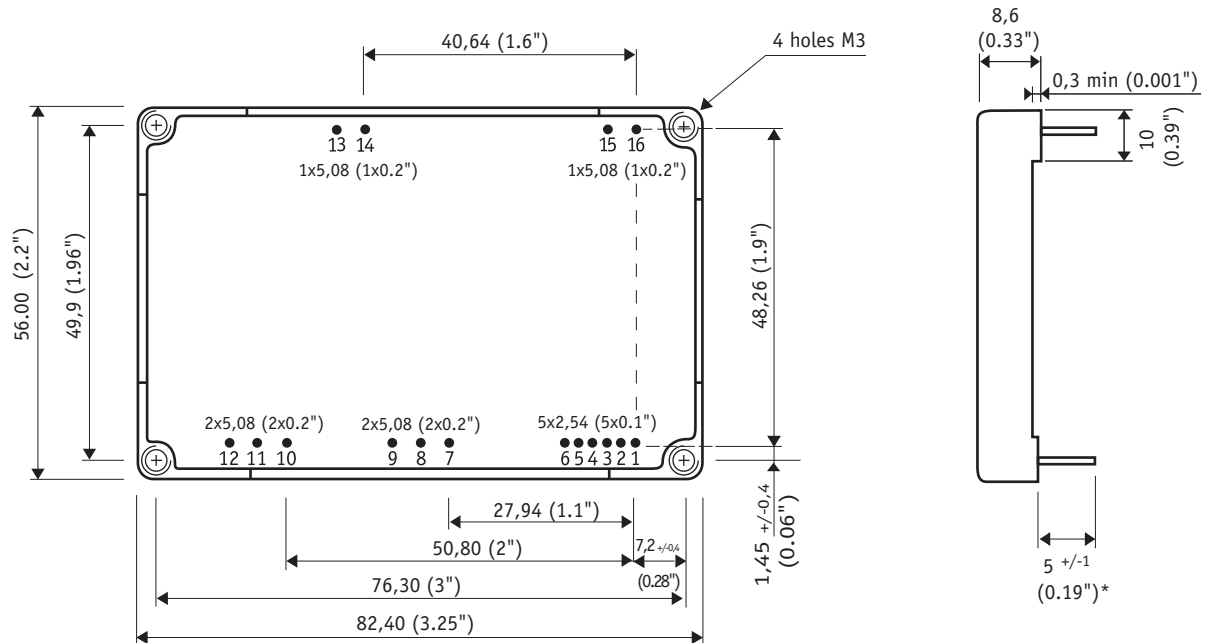

16- Materials

Case : Matallic black anodized coating.
Pins : Plated with pure matte tin over nickel underplate.

Pin dimensions : \varnothing 0,83mm (0.032")
* Except pin 15 : 6 mm (0.23") long

17- Product Marking

Upper face : Company logo.
Side face : Module reference, option, date code : year and week of manufacturing.

18- Connections

Pin	Single line	Dual line		Triple line				
	1 Output	2 Outputs		3 Outputs		4 Outputs	5 Outputs	6 Outputs
	CGDI - 0 - 0	CGDI - 0 -	CGDI - 0	CGDI - 0 -	CGDI -	CGDI -	CGDI -	CGDI -
1	Output 1 + (+Vo1)	Output 1 + (+Vo1)	Output 1 + (+Vo1)	Output 1 + (+Vo1)	Output 1 + (+Vo1)	Output 1 + (+Vo1)	Output 1 + (+Vo1)	Output 1 + (+Vo1)
2	Sense +	Sense +	Sense +	Sense +	Sense +	Sense +	Sense +	Do not connect
3	Trim	Trim	Trim	Trim	Trim	Trim	Trim	Do not connect
4	Do not connect	Do not connect	Do not connect	Do not connect	Do not connect	Do not connect	Do not connect	Return 1 (Go1)
5	Sense -	Sense -	Sense -	Sense -	Sense -	Sense -	Sense -	Do not connect
6	Return 1 (Go1)	Return 1 (Go1)	Return 1 (Go1)	Return 1- (Go1)	Return 1 (Go1)	Return 1 (Go1)	Return 1 (Go1)	Output 1 - (-Vo1)
7	Do not connect	Do not connect	Output 2+ (+Vo2)	Do not connect	Output 2 + (+Vo2)	Output 2 + (+Vo2)	Output 2 + (+Vo2)	Output 2 + (+Vo2)
8	Do not connect	Do not connect	Do not connect	Do not connect	Do not connect	Do not connect	Return 2 (Go2)	Return 2 (Go2)
9	Do not connect	Do not connect	Return 2 (Go2)	Do not connect	Return 2 (Go2)	Return 2 (Go2)	Output 2 - (-Vo2)	Output 2 - (-Vo2)
10	Do not connect	Output 2+ (+Vo2)	Do not connect	Output 2+ (+Vo2)	Output 3 + (+Vo3)	Output 3 + (+Vo3)	Output 3 + (+Vo3)	Output 3 + (+Vo3)
11	Do not connect	Do not connect	Do not connect	Return 2 (Go2)	Do not connect	Return 3 (Go3)	Return 3 (Go3)	Return 3 (Go3)
12	Do not connect	Return 2 (Go2)	Do not connect	Output 2- (-Vo2)	Return 3 (Go3)	Output 3 - (-Vo3)	Output 3 - (-Vo3)	Output 3 - (-Vo3)
13	- Input (Gi)	- Input (Gi)	- Input (Gi)	- Input (Gi)	- Input (Gi)	- Input (Gi)	- Input (Gi)	- Input (Gi)
14	+ Input (Vi)	+ Input (Vi)	+ Input (Vi)	+ Input (Vi)	+ Input (Vi)	+ Input (Vi)	+ Input (Vi)	+ Input (Vi)
15	Case	Case	Case	Case	Case	Case	Case	Case
16	On/Off	On/Off	On/Off	On/Off	On/Off	On/Off	On/Off	On/Off



Represented by :